



altro

Installation instructions for Altro Tegulis™ wall cladding

updated 03/05/2024

Read all instructions before beginning the installation.

Altro Tegulis has achieved ICC ES certification. For more information scan QR code.



Storage and handling

All Altro materials, panels, adhesives, sealants and all accessories must be stored between 68°F (20°C) – 80°F (27°C) and acclimated to the room which they will be used in at least 24 hours before the installation is to take place. Altro Tegulis panels must be stored on a level flat surface above the ground (risk of condensation on the panels if stored on damp surfaces). Standing the panels against a wall on their side or on uneven surfaces can distort or damage the edges of the panels.

Suitable substrates

Note: Check adhesive data for specific requirements.

- Drywall
- Cement board
- Underlayment-grade plywood
- MDF panels that meet local building codes
- Existing ceramic tiles that are securely bonded (missing or loose tiles must be removed and the appropriate patching compound must be used to fill the void such as a moisture-resistant type)

All substrates must be smooth, sound, primed and dust-free.

Required tools

- Level(s)
- Saw(s) with fine tooth blade(s)
- Hole saw
- Jig saw

- Low-speed mixing drill and epoxy mixing paddle
- Tape measure and pencil
- Small caulking gun (higher thrust ratio gun is needed for AltroFix™ MP600)
- File(s) to remove sharp edges
- Trowel
- Three-wheeled laminate style hand roller
- Spray bottle for isopropyl or denatured alcohol (used for cleaning)

Wall substrate prep

All surfaces must be smooth, sound, dry, and free of contamination. Check walls for flatness especially at seam location(s), make sure seam area is 100% flat to ensure proper fitting for a successful installation. Priming of dusty and overly absorbent surfaces may be necessary. Existing wall tile must be cleaned with TSP (trisodium phosphate) or equivalent to remove soap scum and contaminants, rinsed with clean water and allowed to dry. Do not use solvents to clean substrate as this could cause bonding failure. Any loose tiles should be fixed or made sound.

Optional installation accessories

ALTWF02

Aluminum edge trim / cap strip.

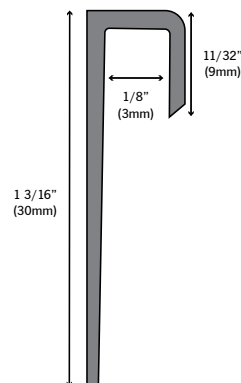

ALTW01

Aluminum edge finishing trim.

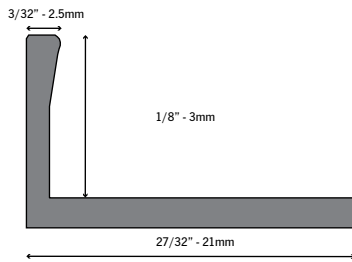

ALTW04

Aluminum internal corner trim.

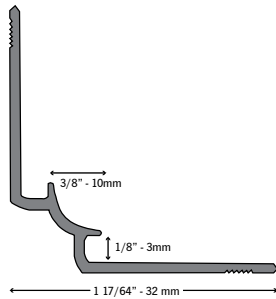

ALTW05

Aluminum external corner trim.

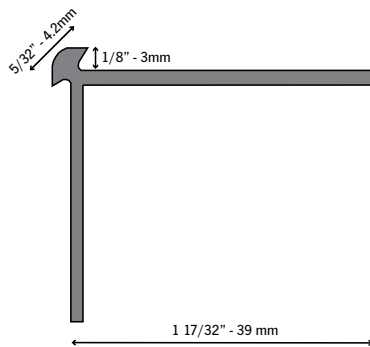

Adhesives

Altro W157

Water-based acrylic adhesive is suitable for surfaces in dry, climate controlled areas and may only be used with absorbent surfaces.

Altro W39

Two-part polyurethane adhesive suitable for wet areas and for all absorbent and non-absorbent surfaces.

Substrate	Altro W39	Altro W157	AltroFix™ MP600
Drywall*	✓	✓**	✓
Plywood	✓	✓	✓
Metal	✓	✗	✓
Ceramic tiles	✓	✗	✗
Plaster	✓	✓	✓
Concrete	✓	✓	✓

*All gypsum joint compound must be primed.

**Altro W157 must not be used for bonding to moisture resistant substrates

AltroFix™ MP600

MS-polymer based adhesive sealant suitable for all absorbent and non-absorbent surfaces. Bonds to almost all materials used in the construction industry, such as aluminium, galvanized and stainless steel, zinc, copper, natural stone, concrete, brick, HPL panels, treated wood, gypsum, glass, various synthetic materials, etc.

Altro Sanitary Sealant

Altro sanitary sealant is a non-toxic, solvent-free, low modulus, multipurpose, one component sealant that is especially formulated for all types of sanitary applications and rooms with high humidity such as bathrooms, kitchens, as well as cold storage cells.

Recommend trowels

Only use approved adhesives and trowels recommended by Altro. Consult adhesive label for additional information. PRB 1/8" (3mm) square notch trowel is recommended for most applications. MLN 3/16" (5mm) square notch trowel is required when installing over existing wall tile.

Half-lap joining method

Note: Altro Tegulis half-lap panels are suitable for both wet and dry environments. Altro W39 or AltroFix™ MP600 must be utilized in wet environments regardless of the substrate. AltroFix™ MP600 cannot be used on existing tile substrates.

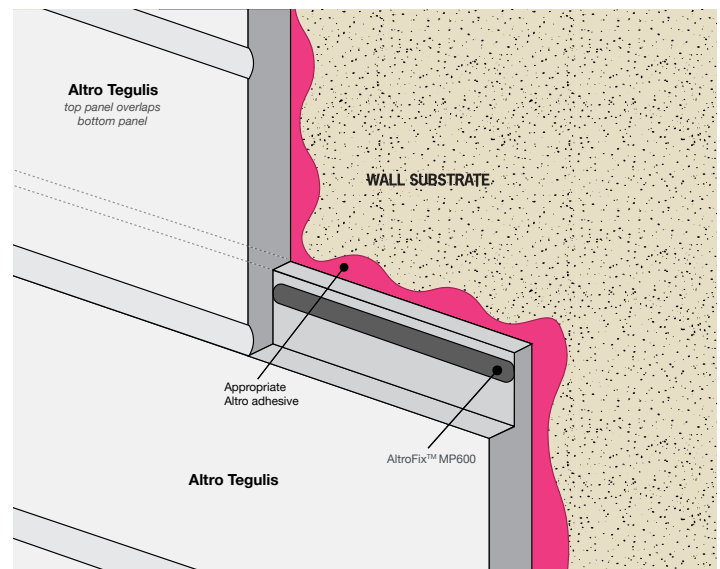

For wet areas only: Measure the inside corner(s) from top to bottom, cut the strips of A839 for each inside corner trims and adhere them using AltroFix™ MP600. Prior to installing the Altro Tegulis panels, apply a bead of AltroFix™ MP600 to the internal corner of the previously installed A839 trims.

Note: The use of A839 is not to be installed when using ALTW04 aluminum internal corner trim.

1. In pencil, apply a datum/level line horizontally on the substrate, this will help when measuring for cutting and aligning the panels to match up the grout lines. Mark the protective film of the panels with the same datum line measurement that corresponds with the line you drew on the substrate. This will aid in matching up to the datum line on the substrate during installation.
2. Start with the bottom panel of the back wall, measure, cut and dry fit. Leave a 1/16" (2mm) gap at perimeter edges, penetrations and abutments to allow for expansion of the panels.
3. Cut and dry fit the top panel and check alignment with bottom panel.

Leave a 1/16" (2mm) gap at perimeter edges, penetrations and abutments to allow for expansion of the panels.

4. Clean the back of the panels with isopropyl or denatured alcohol to remove dust and contaminants.
5. If using Altro W39 two-part adhesive, careful planning must take place and both top and bottom panels must be cleaned and ready to be installed simultaneously, as the working time of Altro W39 is approximately 30 minutes once it is mixed.
6. Apply appropriate adhesive on the back of the panel with a 1/8" (3mm) square-notched trowel, keeping adhesive 3/4" (20mm) away from the edges. **Adhesive selection and trowel notch has been determined by substrate and environmental conditions of the application.**
7. Install bottom panel ensuring it is aligned with the pre-established datum/level line. Once in place, use a three-wheeled laminate roller ensuring 100% transfer of adhesive to the substrate.
8. Apply a 1/16" (2mm) bead of AltroFix™ MP600 to the half lap top edge seam location of the installed bottom panel. The Parabond AP 600 must be applied above the visible seam so as not to ooze out on to the surface of the panels.
9. Apply adhesive to the back of the top panel.
10. Align the top panel to the bottom panel by initially holding the top panel with a slight angle away from the substrate. Place seam edge onto the bottom panel seam avoiding the AltroFix™ MP600. Once in place gently bring the top panel towards the substrate, press home ensuring the seam edges of both panels are tight and no adhesive is oozing through.
11. Using a three-wheeled hand roller, roll the panel in both directions to ensure proper transfer is made to the substrate. Immediately clean up any excess adhesive using isopropyl or denatured alcohol and a clean white cloth.
12. For the sidewalls, measure cut while using the datum line to ensure the grout lines match up. Dry fit each panel to check for fit and alignment. Remember to leave a 1/16" (2mm) gap around the perimeter, penetrations and abutments to allow for expansion.
13. Again, have both side panels cleaned and ready to install simultaneously when working with Altro W39 two-part adhesive.
14. Follow the above instructions for installing the side panels.
15. Once all the panels have been installed apply a bead of Altro sanitary sealant along the inside corners, abutments, penetrations and any exposed edges.
16. If required for the side panels, there are the options of a two-part start and edge trim A833 or the one-part start and edge trim G833.

Interlocking joining method

Note: Altro Tegulis interlocking joining panels are not recommended for wet environments.

1. Predetermine the best layout to minimize waste and best location(s) for interlocking seams.
2. In pencil, apply a datum/level line horizontally on the substrate; this will help when measuring for cutting and aligning the panels to match up the grout lines. Mark the protective film of the panels with the same datum line measurement that corresponds with the line you drew on the substrate. This will aid in matching up to the datum line on the substrate during installation.
3. Start by measuring the first panel using the datum line as a reference

Full spread adhesive application

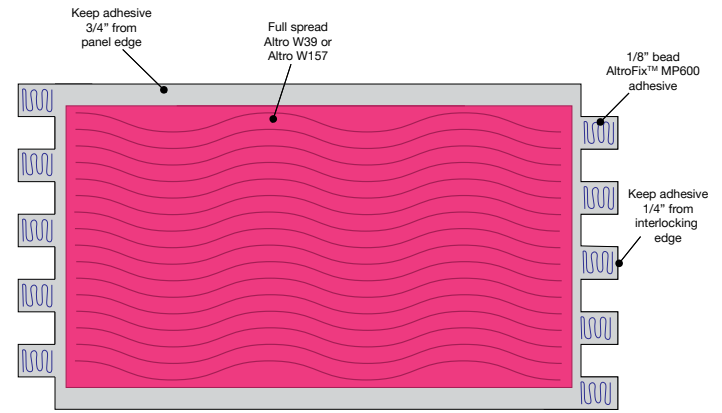

Grid pattern adhesive application

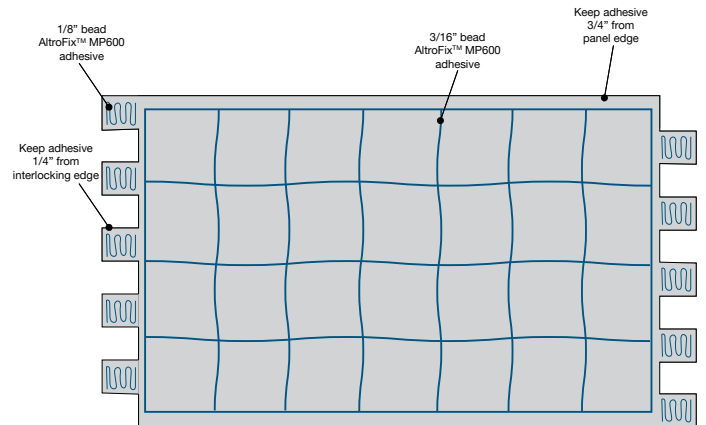

for cutting around penetrations, abutments and overall length of panel(s). Cut panels, and a best practice is always dry fit the panels and make adjustments if necessary before applying adhesive to the back of the panels. Leave a 1/16" (2mm) gap around the perimeter and around all cut-outs to allow for the expansion of panels.

4. Clean the back of the panel with isopropyl or denatured alcohol. *There are two adhesive application options available for the Altro Tegulis interlocking joining panels. One being full spread adhesive either Altro W157 or Altro W39 (this selection is determined by the substrate) or AltroFix™ MP600 used in a grid pattern.*
See adhesive application diagrams below.
5. Using the full spread adhesive option, apply adhesive to the back of the panel using a 3mm (1/8") square-notched trowel, keeping the adhesive 3/4" (20mm) away from the panel edges. Apply a 1/8" (3mm) wide bead of AltroFix™ MP600 adhesive to the interlocking edge, keeping the adhesive away from the edges approximately 6mm (1/4") to avoid adhesive oozing out of the seams. Clean any excessive adhesive up immediately using a clean white cloth with isopropyl or denatured alcohol.
 - If using the AltroFix™ MP600 grid pattern adhesive option, apply a 3/16" (5mm) wide bead in a 12" (300mm) grid pattern, keeping the adhesive 3/4" (20mm) away from the panel edges. Also apply a 1/8" (3mm) wide bead of to the interlocking edge, keeping the adhesive away from the edges approximately 1/4" (6mm) to avoid adhesive oozing out of the seams. Clean any excessive adhesive up immediately using a clean white cloth with isopropyl or denatured alcohol.

- Install panel ensuring it is aligned with the pre-established datum/level line.
- Once in place, use a three-wheeled laminate roller to roll the panel in all directions to ensure 100% transfer of adhesive to the substrate.
- Do not allow excess adhesive to remain in the seam interlocking area if the next panel will not be installed within thirty minutes as it will harden and could create an uneven seam. Excessive adhesive on the wall substrate must be removed using a small putty knife or equivalent.
- Continue measuring and trimming/cutting adjacent panels where required and leave a gap of 1/16" (2mm) around the perimeter, penetrations and abutments for expansion of the panels. It's always a best practice to dry fit the panels to ensure a good fit and taking care with the interlocking edges.
- Once all the panels have been installed, apply a bead of Altro sanitary sealant along the inside corners, abutments, penetrations and any exposed edges.
- On the side panels it may be necessary to use trims, A833 two-part start and edge trim or the one part start and edge trim G833.

Two-part joint strip method

Note: Altro Tegulis installed with two part joint strips are suitable for both wet and dry environments. Altro W39 adhesive must be utilized in wet environments regardless of the substrate.

For wet areas only: Measure the inside corner(s) from top to bottom, cut the strips of A839 for each inside corner trims and adhere them using AltroFix™ MP600 adhesive. Prior to installing the Altro Tegulis panels, apply a bead of AltroFix™ MP600 to the internal corner of the previously installed A839 trims.

- In pencil, apply a datum/level line horizontally on the substrate approximately at eye height. This is used for the calculation of measurements for cutting and aligning the panels. Apply the same datum line on the protective film of the panels. This will aid in matching up to the datum line on the substrate during installation.
- Starting with the first panel, measure, cut and dry fit. Leave a 1/16" (2mm) gap at perimeter edges, penetrations and abutments to allow for expansion of the panels.
- Clean the back of the panel(s) with isopropyl or denatured alcohol to remove dust and contaminates.
- Apply 1" (25mm) wide black butyl tape to the back of the panel just below the datum line and just below the top edge of the panel(s). Transfer the datum line on to the back of the panel with pencil. Keep tape away from edges approximately 3/4" (20mm) to allow the backer to slide behind the panel (leave tape cover on until the adhesive has been applied).
- Apply appropriate adhesive on the back of the panel with a 1/8" (3mm) square-notched trowel, keep adhesive 3/4" (20mm) away from the edges. **Adhesive selection and trowel notch is determined by substrate and environmental conditions of the application.**
- Remove protective tape cover and place the panel on the wall using the datum line(s) to match up to on the substrate.
- Once in place, use a three-wheeled laminate roller to roll the panel in

all directions to ensure 100% transfer of adhesive to the substrate.

- Once the panel is adhered to the wall, slide the backer part of the two-part joint strip under the installed panel. Leave a small gap 1/16" (2mm) between the panel edge and the center part of the

Tape and adhesive application

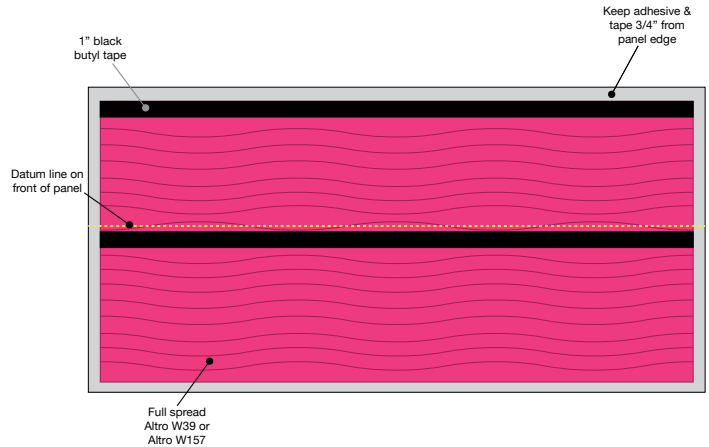

channel of the joint strip (there is a slightly indented line in the strip to use as a guide).

- Continue fitting and installing adjacent panels following the above instructions and remember to leave a 1/16" (2mm) gap around the backer, penetrations and abutments.
- The front joint strip covers should be initially positioned by hand pressure. They can then be fully set in place by tapping with a white non-marring rubber mallet or a hand roller.
- On the side panels it may be necessary to use trims, A833 two-part start and edge trim or the one part start and edge trim G833.
- Once all the panels have been installed, apply a bead of Altro sanitary sealant along the inside corners, abutments, penetrations and any exposed edges.

Installation Instructions for Altro Tegulis wall panels

Note: Once installation is complete. Remove protective film and clean

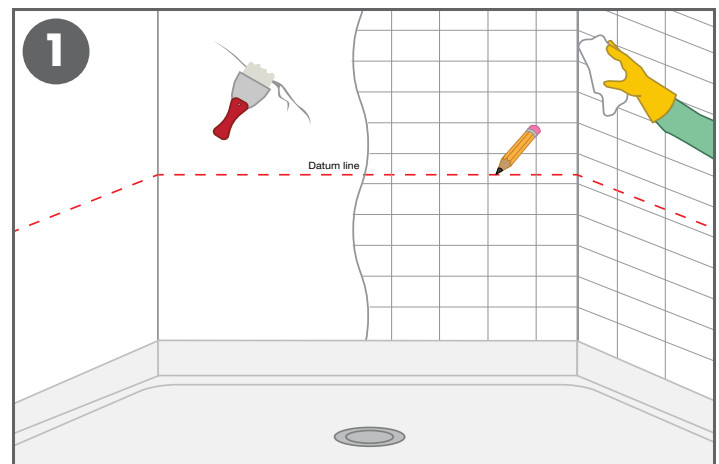

with Altro anti-static solution. Leave for 24 hours prior to being put into use.

- All surfaces must be smooth, sound, dry, and free of contamination. Check walls for flatness especially at seam location(s). Existing wall tile must be cleaned with TSP (trisodium phosphate) or equivalent to remove soap scum and contaminates, rinsed with clean water and

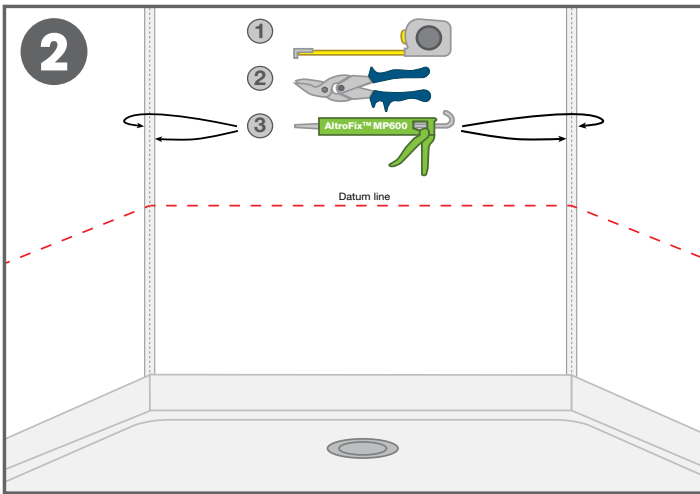

allowed to dry. Any loose tiles must be fixed and made sound. Lastly add a datum line with pencil.

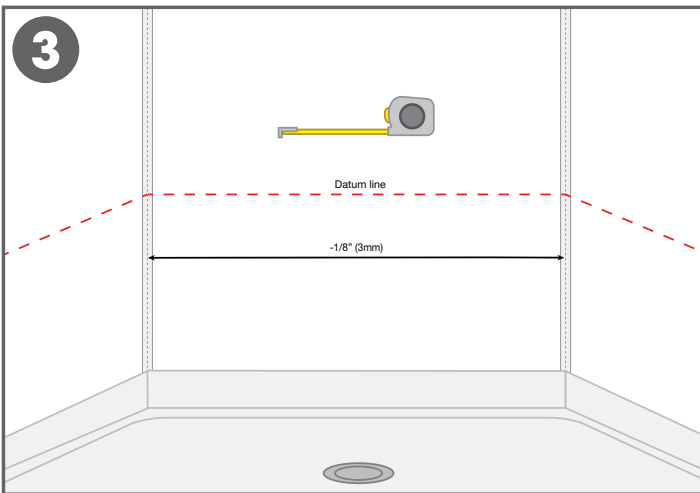

2. Measure the inside corner(s), cut the strips of A839 to length, and adhere them using AltoFix™ MP600.

3. Measure distance between the A839 allowing for 1/8" (3mm) tolerance. If distance is 48" or less, the panel can be installed

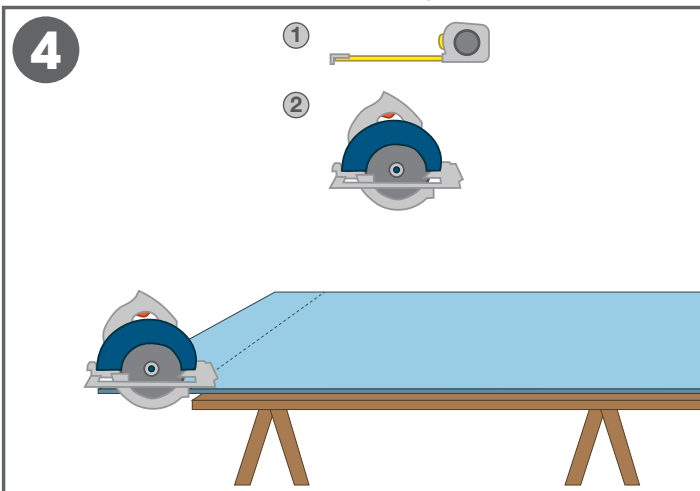

vertically. Any distance over 48" and in a wet area application will require the half-lap seam method. Orientation of the panels will need to be determined prior to the ordering process.

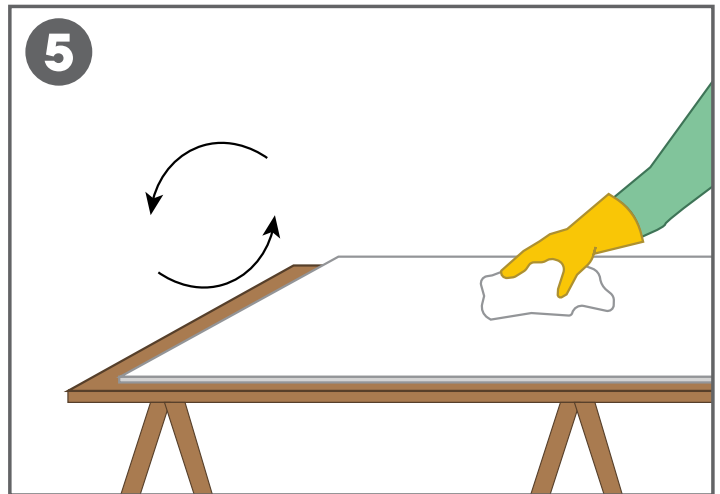

4. Measure and mark out the previously determined measurements onto panel. Make necessary cuts. Always dry fit to ensure proper fit.

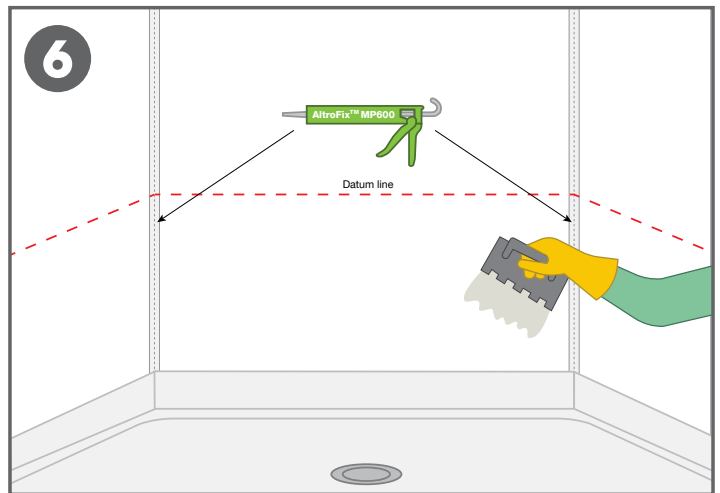

5. Clean the back of the panels with glass cleaner or similar to remove dust and contaminants.

6. Depending on the environmental conditions and substrate, mixing of two-part adhesives may be necessary. Follow adhesive label and

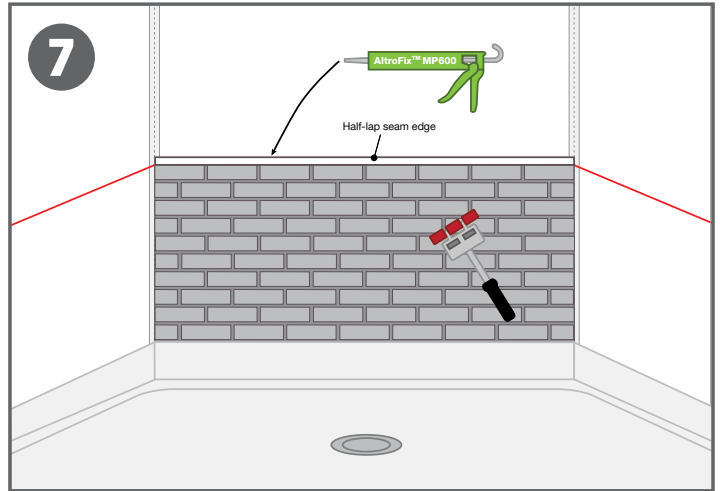

mix thoroughly. Apply adhesive to back of panel and/or to the wall substrate. Apply a bead of AltoFix™ MP600 to the internal corner of the previously installed A839 trims.

7. Install panel into proper position with correct spacing and aligned

Overlap installation for Altro Whiterock™ Recess Shelf A900 with Altro Tegulis

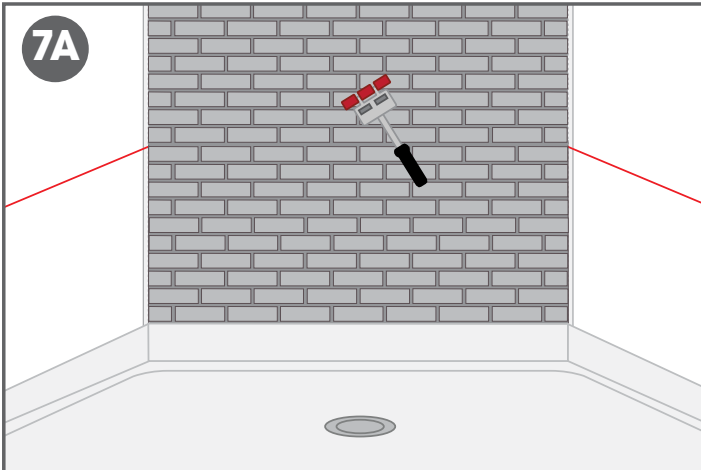

on or with datum line. Use a 3-wheeled wall roller to roll entire panel to ensure proper bond to wall substrate. Apply 1/16"(2mm) bead of AltroFix™ MP600 to the half-lap seam edge. Be sure to keep it above

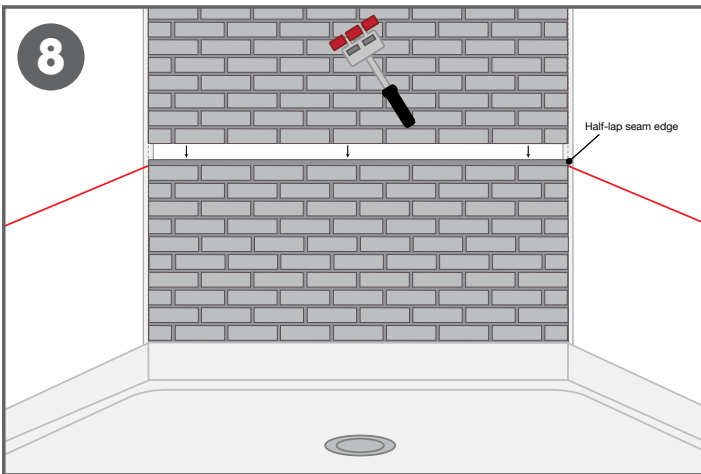

the visible seam edge.

7A. If the distance was 48" or less the panel will be installed vertically. Install panel into the correct position. Use a 3 wheeled wall roller to

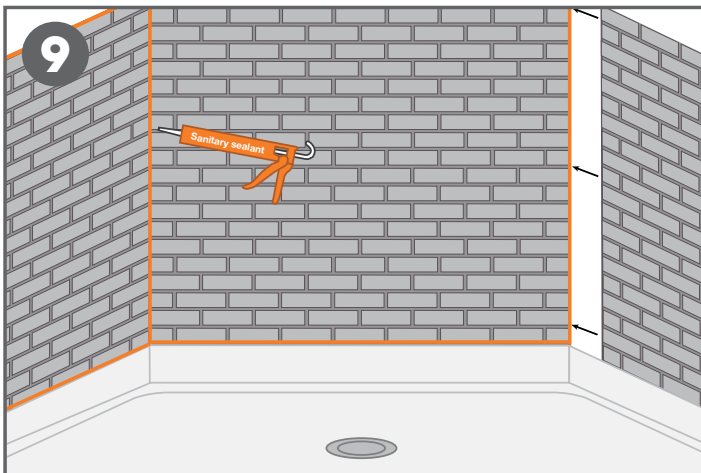

roll entire panel to ensure proper bond to the substrate.

8. Install the top panel as previously instructed with correct space and properly aligned with the previously installed bottom panel. Use a 3-wheeled wall roller to roll entire panel to ensure proper bond to

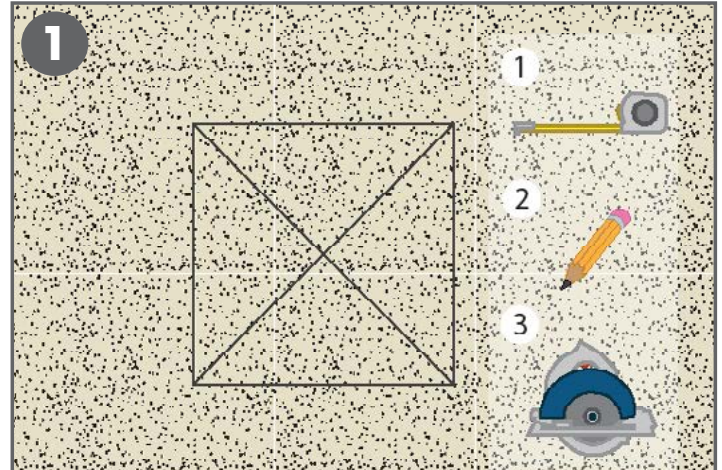

1. Use datum line or similar to determine location on wall substrate for placement of the Altro Whiterock Recessed Shelf A900. Measure, mark, and cut wall substrate accordingly.



2. There must be adequate support within the wall substrate to hold the Altro Whiterock Recessed Shelf A900 and weight of its contents.

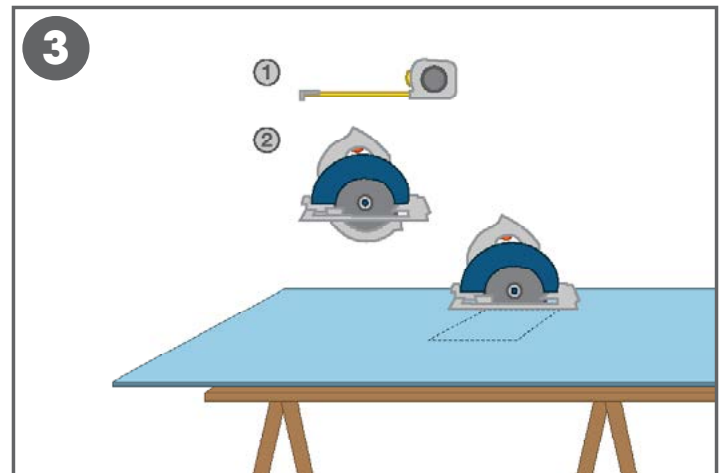

3. Transfer the measurements to the Altro Tegulis panel and cut the opening, which will be approximately 10 1/8" x 10 1/8" for the recessed body to fit into the cut out with ease.

Note: The overlap installation of the Altro Whiterock Recessed Shelf A900 is not intended to be done in behavioral mental health applications and areas where the public may pick or peel at the shelf.

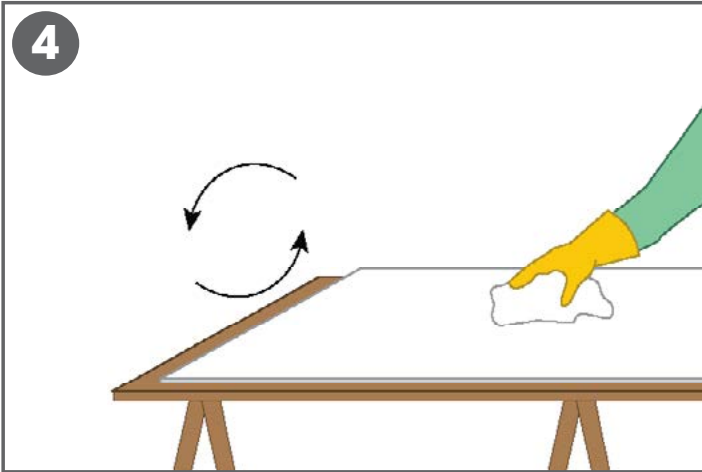

4. Turn the Altro Tegulis panel over and clean the back with isopropyl alcohol or similar.

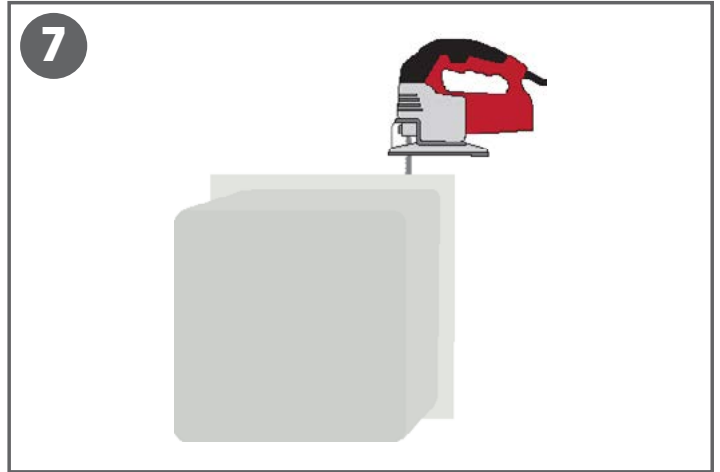

7. The Altro Whiterock Recessed Shelf A900 outer flanged can be trimmed if desired.

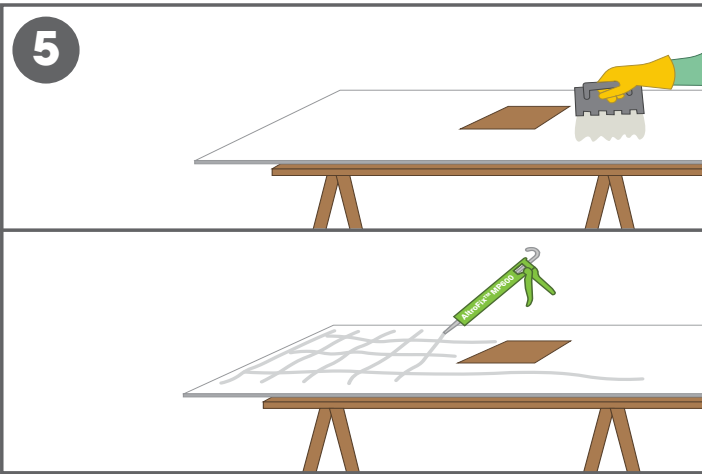

5. Apply Altro W39 adhesive with appropriate trowel or apply AltroFix™ MP600 in a grid pattern.

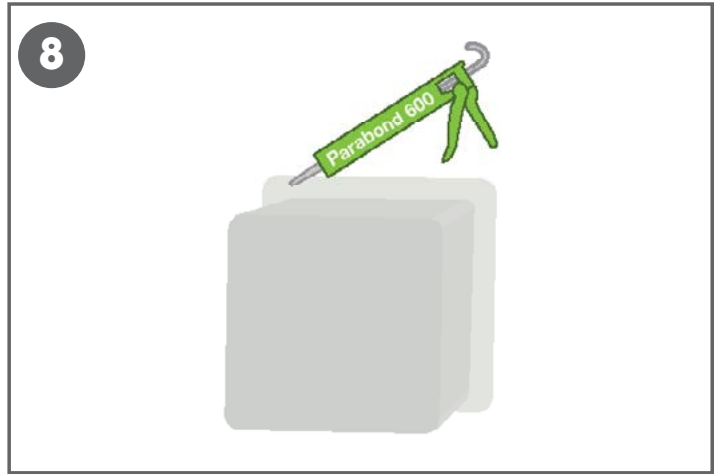

8. Apply AltroFix™ MP600 to the back side of the flange. Install the recessed shelf and press/roll the flange area to ensure the adhesive bonds to the Altro Tegulis panel.

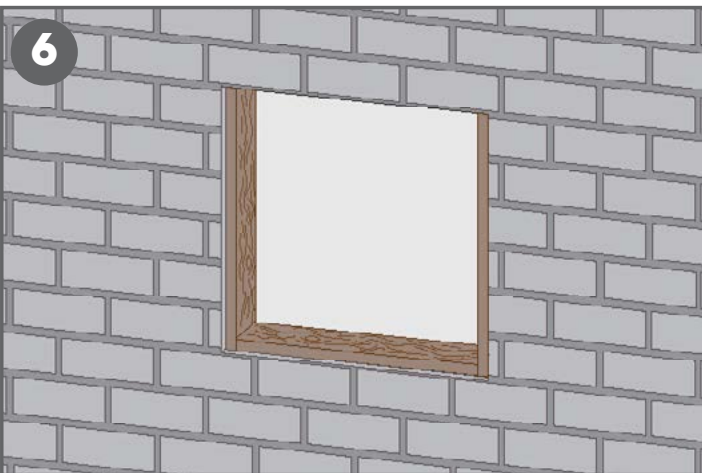

6. Install the panel per the Altro Tegulis installation guide. Be sure to use a wall roller over entire panel to ensure a proper adhesive bond to the substrate.

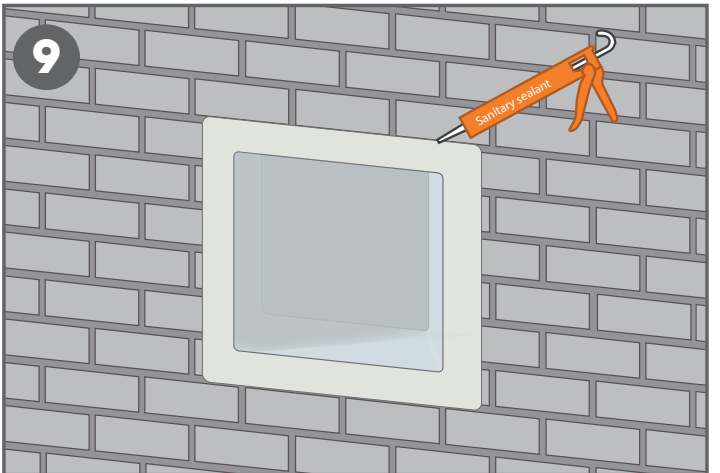

9. Once installation is complete, the edges of the Altro Whiterock Recessed Shelf A900 must be sealed with Altro Sanitary Sealant to prevent water ingress.

Installation instructions for overlapping Altro Tegulis wall panels

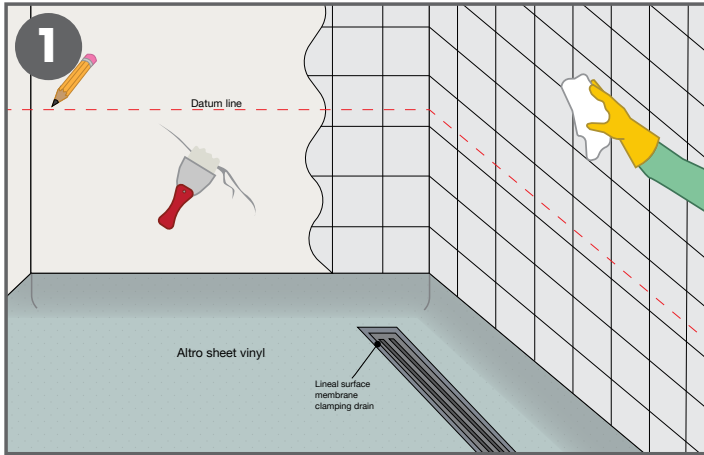

1. All surfaces must be smooth, sound, dry, and free of contamination. Check walls for flatness especially at seam location(s). Existing wall tile must be cleaned with TSP (trisodium phosphate) or equivalent to remove soap scum and contaminates, rinsed with clean water and allowed to dry. Any loose tiles must be fixed and made sound. Lastly add a datum line with pencil.

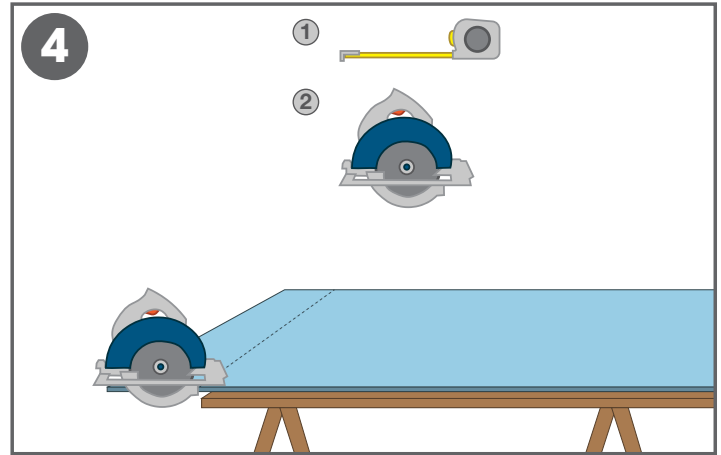

4. Measure and mark out the previously determined measurements onto panel. Make necessary cuts. Always dry fit to ensure proper fit.

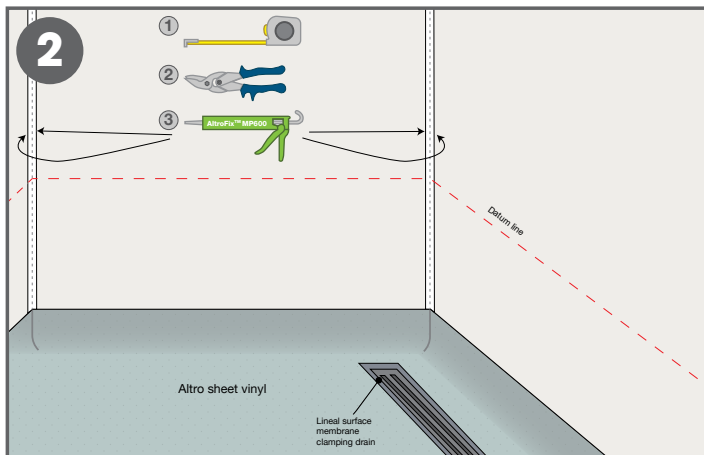

2. Measure the inside corner(s), cut the strips of A839 to length, and adhere them using AltroFix™ MP600.

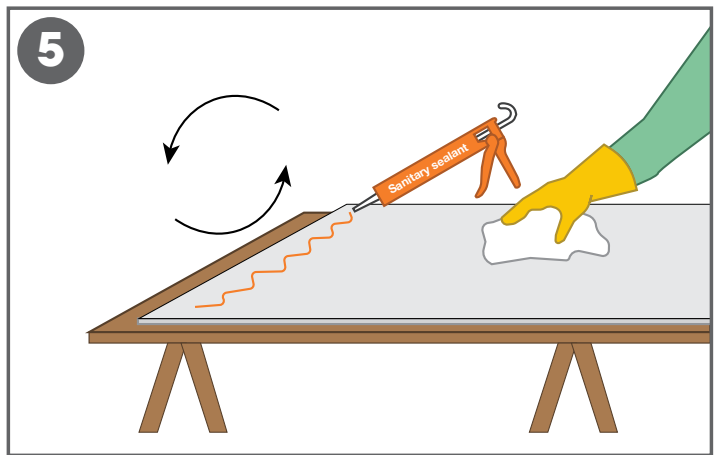

5. Clean the back of the panels with glass cleaner or similar to remove dust and contaminates. Apply Altro sanitary sealant on the back of the panel where it will overlap the existing flash covered flooring.

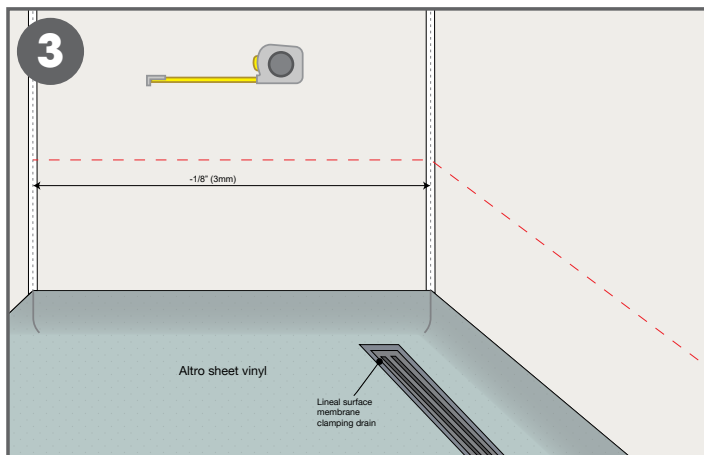

3. Measure distance between the A839 allowing for 1/8" (3mm) tolerance.

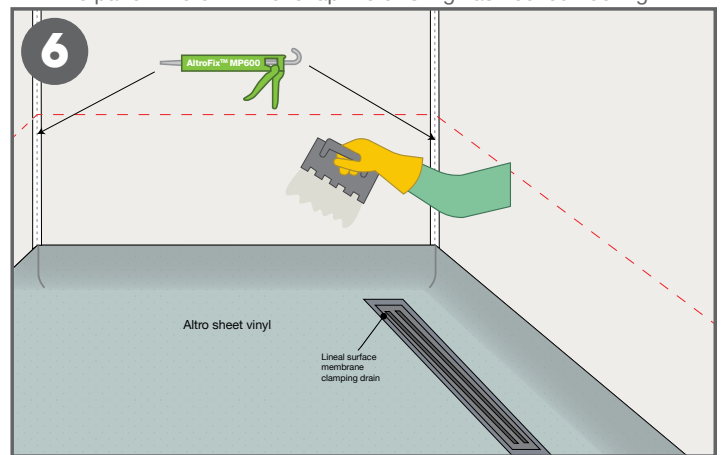

6. Depending on the environmental conditions and substrate, mixing of two-part adhesives may be necessary. Follow adhesive label and mix thoroughly. Apply adhesive to back of panel and/or to the wall substrate. Apply a bead of AltroFix™ MP600 to the internal corner of the previously installed A839 trims.

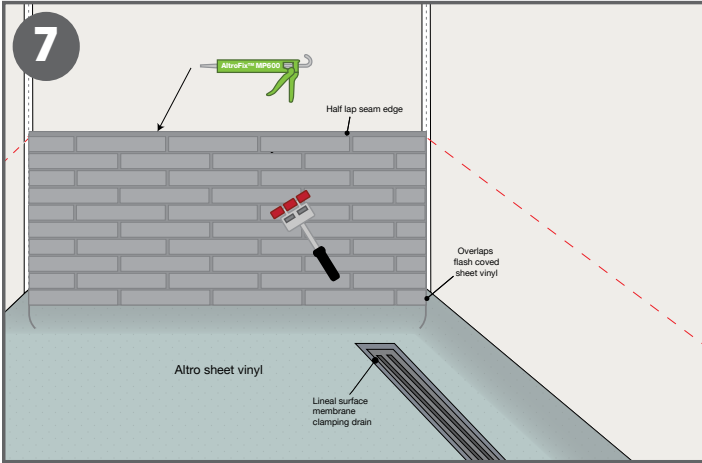

7. Install panel into proper position with correct spacing and aligned on or with datum line. Use a 3-wheeled wall roller to roll entire panel to ensure proper bond to wall substrate. Apply 1/16" (2mm) bead of AltroFix™ MP600 to the half-lap seam edge. Be sure to keep it above the visible seam edge.

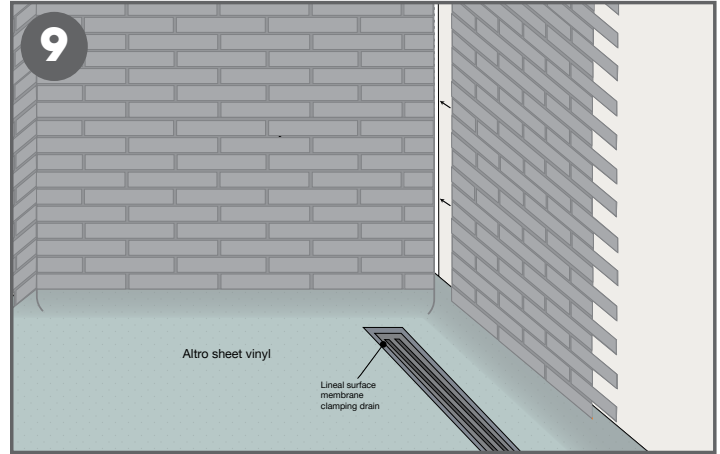

9. Additional wall panels that are not in direct contact with continuous moisture can be installed vertically with the interlocking joining method. This allows full panels to be installed without any horizontal seams. Install adjacent panels as previously instructed.

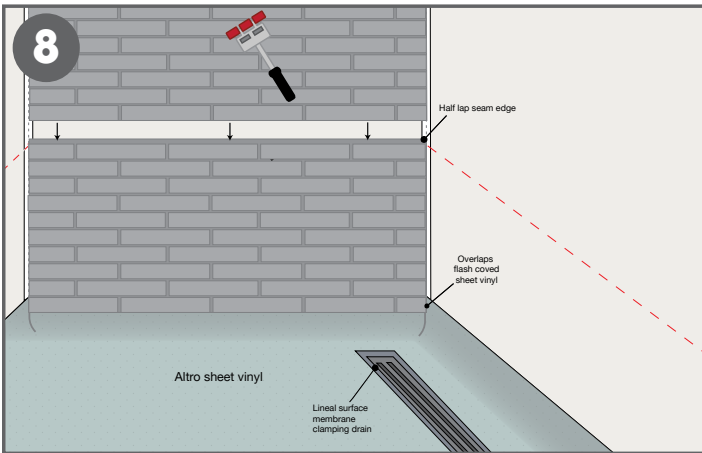

8. Install the top panel as previously instructed with correct space and properly aligned with the previously installed bottom panel. Use a 3-wheeled wall roller to roll entire panel to ensure proper bond to wall substrate.

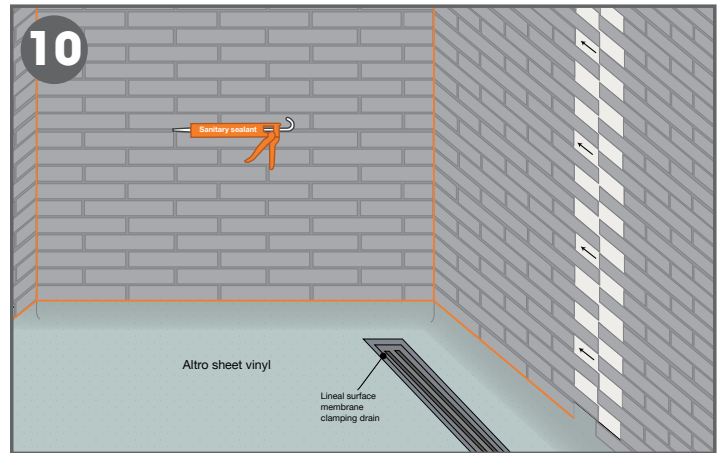

10. Apply Altro sanitary sealant as shown in drawing at inside corners, as well as top and bottom of all panels to prevent moisture ingress.

Note: Once installation is complete, remove protective film and clean with Altro anti-static solution. Leave for 24 hours prior to being put into use.

Altro Tegulis pattern installation combination methods

Chevron		
Half-lap	Interlocking	Two-part
✔	✘	✔

Herringbone		
Half-lap	Interlocking	Two-part
✘	✔	✔

Hexagon		
Half-lap	Interlocking	Two-part
✘	✔	✔

Mosaic 1"x 1"		
Half-lap	Interlocking	Two-part
✔	✔	✔

Mosaic 2"x 2"		
Half-lap	Interlocking	Two-part
✔	✔	✔

Square 4"x 4"		
Half-lap	Interlocking	Two-part
✔	✔	✔

Stacked 3"x 12"		
Half-lap	Interlocking	Two-part
✔	✘	✔

Subway 3"x 6"		
Half-lap	Interlocking	Two-part
✔	✔	✔

Subway 3"x 12"		
Half-lap	Interlocking	Two-part
✔	✔	✔

Subway 4"x 10"		
Half-lap	Interlocking	Two-part
✔	✔	✔

- ✔ = Horizontal installs only
- ✔ = Vertical installs only